

MCT 88

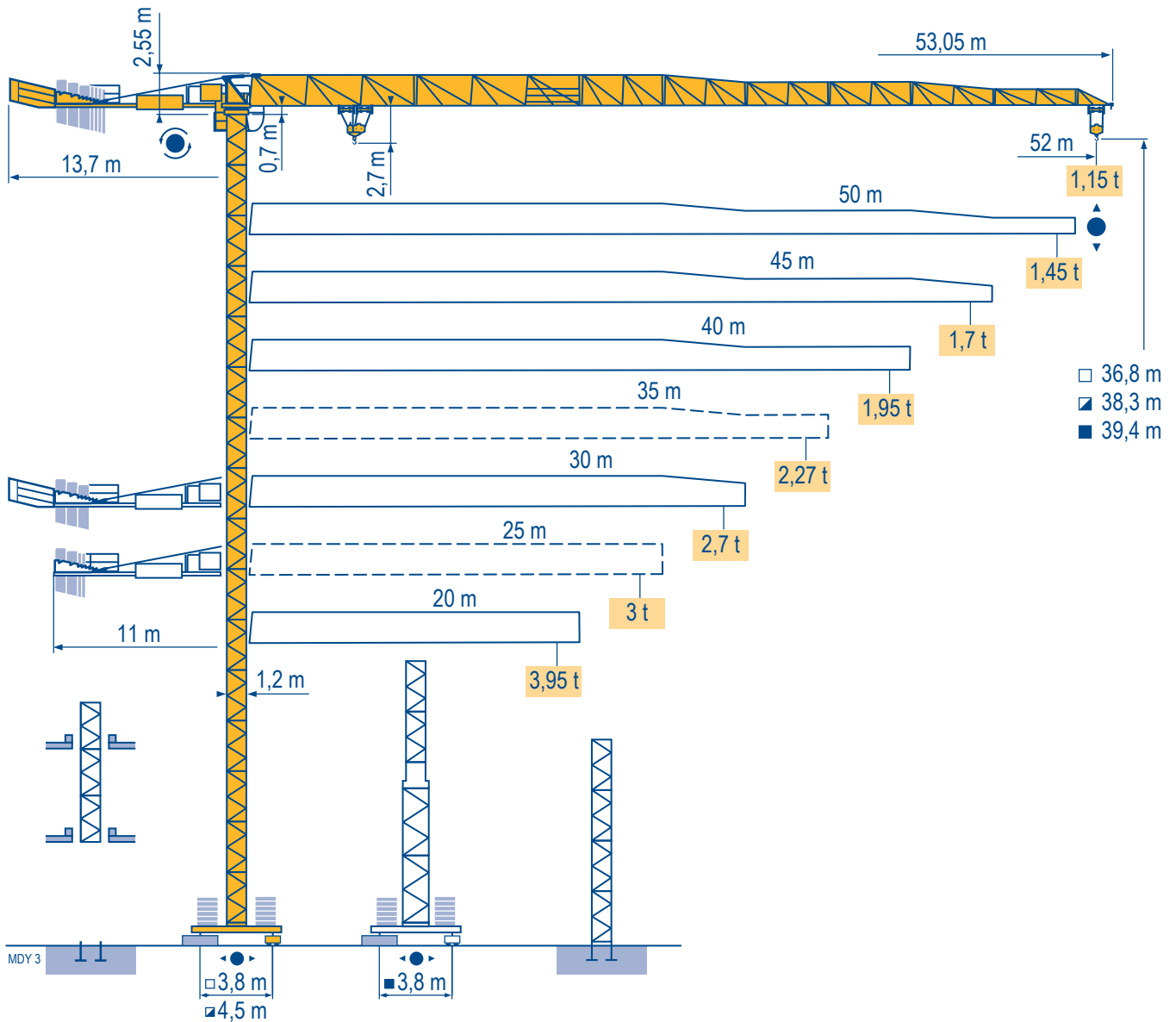

City Topless

Mat / Réactions \square 1,2 m

Maste /
Eckdrücke

20 m \Rightarrow 52 m

Masts /

Reactions

Mástil /

Reacciones

Torre / Reazioni

Tramo /

Reações

MDY 3

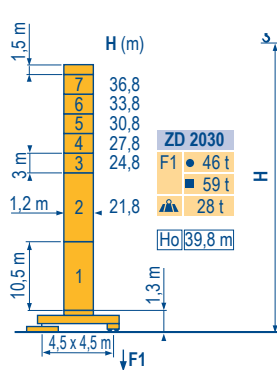
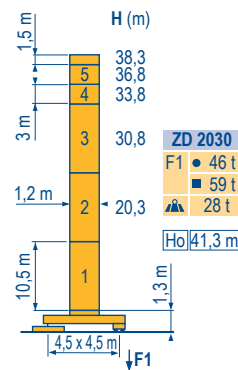
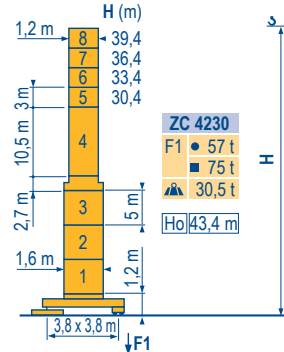
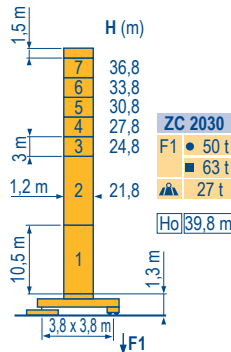
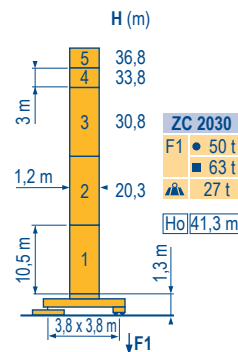
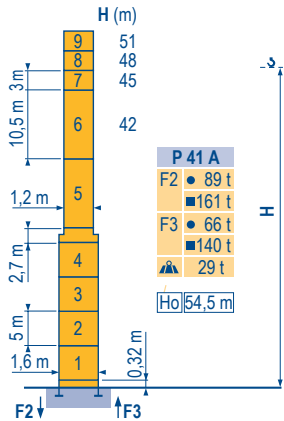
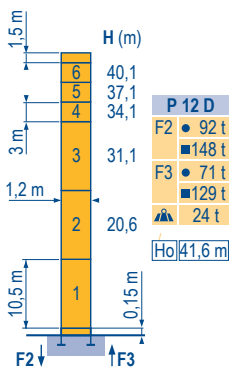
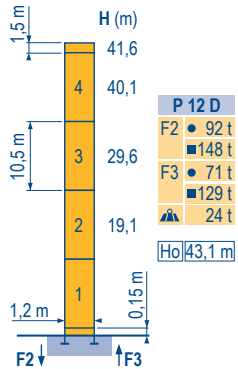
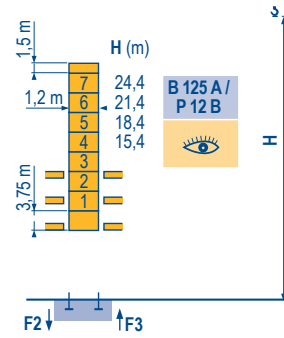
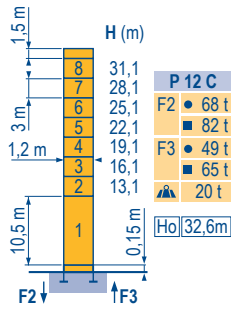
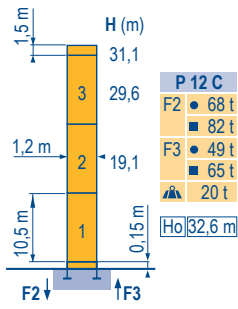

ZC 2030 - ZC 4230 - ZD 2030



CityTopless
MCT 88



F

● Réactions en service
■ Réactions hors service
▲ A vide sans lest (ni train de transport) avec flèche et hauteur maximum.

Ho

H sans cabine

D

● Reaktionskräfte in Betrieb
■ Reaktionskräfte außer Betrieb
▲ Ohne Last, Ballast (und Transportachse), mit Maximalausleger und Maximalhöhe.

H Ohne Fahrerhaus

GB

● Reactions in service
■ Reactions out of service
▲ Without load, ballast (or transport axes), with maximum jib and maximum height.

H without cab

E

● Reacciones en servicio
■ Reacciones fuera de servicio
▲ Sin carga, sin lastre, (ni tren de transporte), flecha y altura máxima.

H sin cabina

I

● Reazioni in servizio
■ Reazioni fuori servizio
▲ A vuoto, senza zavorra (ne assali di trasporto) con braccio massimo e altezza massima.

H senza cabina

P

● Reações em serviço
■ Reações fora de serviço
▲ Sem carga (nem trem de transporte)- sem lastro com lança e altura máximas.

H sem cabine

Courbes de charges

Lastkurven

Load diagrams

Curvas de cargas

Curve di carico

Curva de cargas

MDY 1

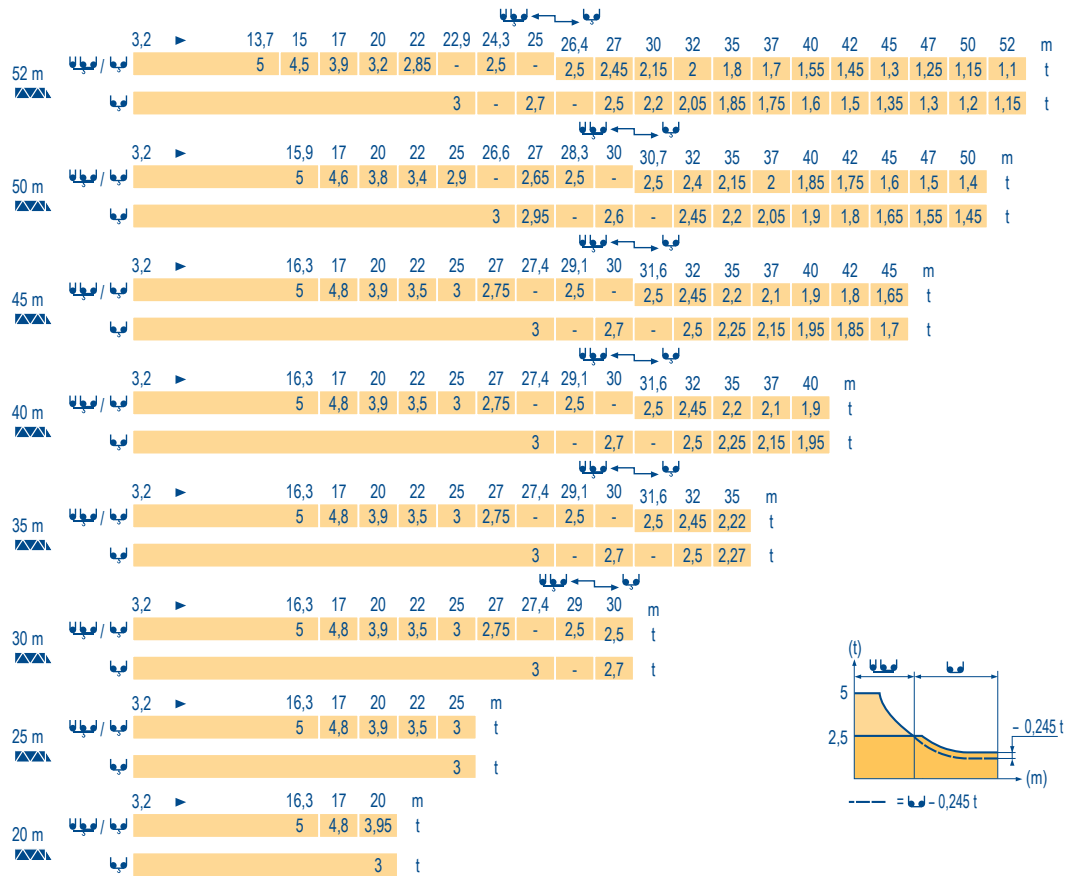

Télescopage sur dalles
Kletterkrane im Gebäude
Climbing crane
Telescopage gruas trepadoras
Gru in cavedio
Telescopagem sobre lages

MDY 2

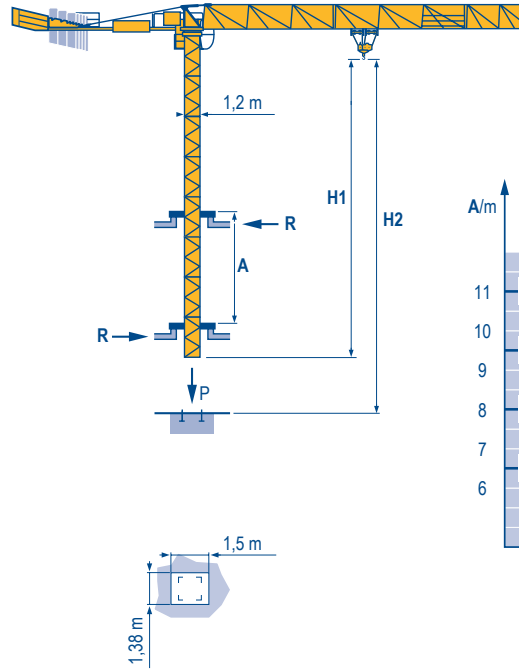

B 125 A

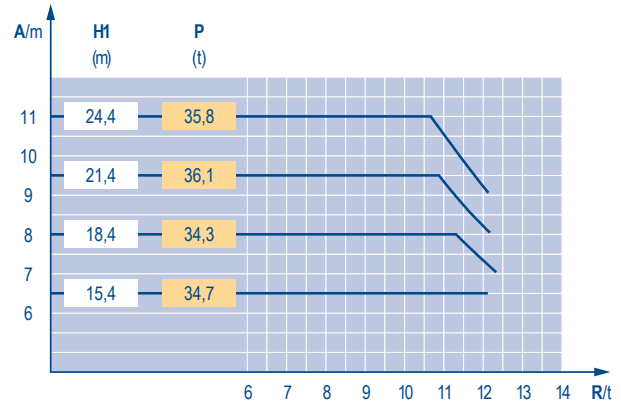





City Topless MCT 88



	F	D	GB	E	I	P
A	Distance entre cadres	Abstand zwischen den Rahmen	Distance between collars	Distancia entra marcos	Distanza fra i telai	Distância entre quadros
H1	Hauteur grue	Kranhöhe	Crane height	Altura grúa	Altezza gru	Altura da grua
P	Poids de la grue(en service)	Krangewicht (in Betrieb)	Crane weight (in service)	Peso de la grúa (en servicio)	Peso della gru (in servizio)	Peso da grua (em serviço)
R	Réaction horizontale	Horizontalkräfte	Horizontal reaction	Reaccion horizontal	Reazione orizzontale	Reacção horizontal
	Voir télescopage sur dalles	Siehe Kletterkrane im Gebäude	See climbing crane	Veja grua trepadora	Consultare gru in cavedio	Ver telescopagem sobre lages

Mécanismes
Antriebe
Mechanisms
Mecanismos
Meccanismi
Mecanismos

MDY 3

		U						U				ch - PS hp	kW														
▲	15 LVF 13 Optima	m/min	2,8	→	7,6	→	24	→	42	→	56	1,4	→	3,8	→	12	→	21	→	28	15	11	200 m				
		t	2,5		2,5		2,5		1,4		0,8	5		5		5		2,8		1,6							
	25 LVF 13 Optima	m/min	4	→	11	→	34	→	56	→	70	→	82	2	→	6	→	17	→	28	→	35	→	41	25	18	329 m
		t	2,5		2,5		2,5		1,45		1,1		0,65	5		5		5		2,9		2,2		1,3			
●	15 LVF 15 Optima	m/min	2,3	→	6,1	→	19	→	34	→	46											15	11	159 m			
		t	3		3		3		1,7		0,95																
●	25 LVF 15 Optima	m/min	3,6	→	9,6	→	30	→	48	→	60	→	72											25	18	228 m	
		t	3		3		3		1,7		1,3		0,75														
●	RVF 61 Optima +	tr/min U/min - rpm																0 → 0,8	7,5	5,5							
◀ ▶	4 DVF 3	m/min																0 → 63	5	3,7							
	ZC 2030 ZD 2030	RT 224																25	2 x 4	2 x 2,9							
	ZC 4230	RT 324																12,5 - 25	2 x 7	2 x 5,2							
CEI 38 		IEC 38															kVA										
400 V (+6% -10%) 50 Hz																	15 LVF : 25 kVA 25 LVF : 35 kVA										

15 LVF 13 Optima

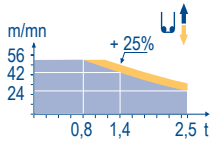

25 LVF 13 Optima

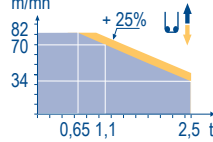

15 LVF 15 Optima

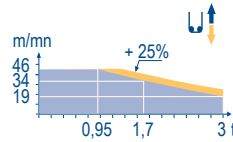

25 LVF 15 Optima

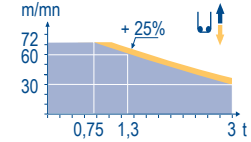

F

Levage
Distribution
Orientation
Translation

D

Heben
Katzfahren
Schwenken
Kranfahren

GB

Hoisting
Trolleying
Slewing
Travelling

E

Elevación
Distribución
Orientación
Traslación

I

Sollevamento
Distribuzione
Rotazione
Traslazione

P

Elevação
Distribuição
Rotação
Translação



Document commercial non contractuel. Pour toute information technique se référer à la notice correspondante.

Unverbindliches Vertriebsdokument. Für technische Informationen, siehe die entsprechenden Anweisungen.

This commercial document is not legally binding. For any technical information, please refer to the corresponding instructions.

Documento comercial non contractuel. Para cualquier información técnica, ver la noticia correspondiente.

Documento commerciale non vincolante, per tutte le informazioni tecniche fare riferimento al catalogo istruzioni.

Documento comercial não contratual. Para qualquer informação técnica complementar consultar as respectivas instruções.



Americas

Tel : +1 888 479 7278
Tel : +1 717 593 2000

Europe - Middle East - Africa

Tel : +33 (0) 4 72 81 50 00
Tel : +44 (0) 191 522 2000

Asia - Pacific

Tel : +65 6264 1188
Fax : +65 6862 4040

www.manitowoccrane.com

18, rue de Charbonnières - B.R.173
69132 ECULLY Cedex - France

Tél. : +33 (0) 4 72 18 20 20
Fax. : +33 (0) 4 72 18 20 00
www.manitowoccrane.com

City Topless MCT 88

Code Q-89985-57_Réf. 2006 40 MDY 4

Copyright.Reproduction interdite © POTAIN 2006